

ENERGIZER NH15-2300

AA

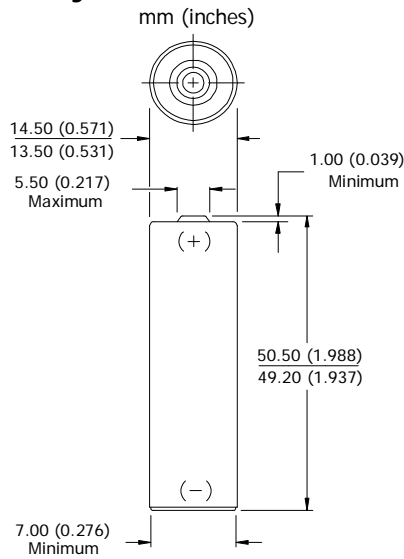

Industry Standard Dimensions



Discharge Characteristics

Typical Performance at 21°C (70°F)

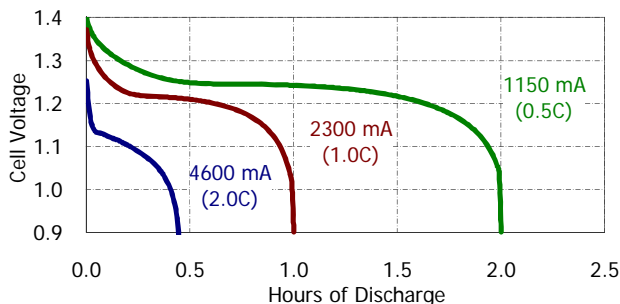
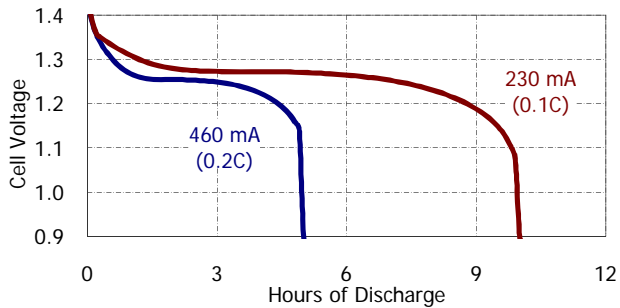

Specifications

Classification:	Rechargeable
Chemical System:	Nickel-Metal Hydride (NiMH)
Designation:	ANSI-1.2H2
Nominal Voltage:	1.2 Volts
Rated Capacity:	2300 mAh* at 21°C (70°F)
Typical Weight:	30.0 grams (1.1 oz.)
Typical Volume:	8.3 cubic centimeters (0.5 cubic inch)
Terminals:	Flat Contact
Jacket:	Plastic

* Based on 460 mA (0.2C rate) continuous discharge to 1.0 volts.

Internal Resistance:

The internal resistance of the cell varies with state of charge, as follows:

<u>Cell Charged</u>	<u>Cell 1/2 Discharged</u>
30 milliohms	40 milliohms
(tolerance of ±20% applies to above values)	

AC Impedance (no load):

The impedance of the charged cell varies with frequency, as follows:

<u>Frequency (Hz)</u>	<u>Impedance (milliohms)</u> (charged cell)
1000	12

Above values based on AC current set at 1.0 ampere.
Value tolerances are ±20%.

Operating and Storage Temperatures:

To maintain maximum performance, observe the following general guidelines regarding environmental conditions:

Charge:	0°C to 40°C (32°F to 104°F)
Discharge:	0°C to 50°C (32°F to 122°F)
Storage:	-20°C to 30°C (-4°F to 86°F)
Humidity:	65±20%

NOTE: Operating at extreme temperatures, will significantly impact battery cycle life.

Important Notice

This data sheet contains typical information specific to products manufactured at the time of its publication.

©Energizer Holdings, Inc. - Contents herein do not constitute a warranty.